



# Joint Adventures Knee Replacement

at Northwestern Medicine Kishwaukee Hospital  
and Northwestern Medicine Valley West Hospital





# Welcome to Northwestern Medicine

Hello and welcome to the Joint Adventures pre-operative program at Northwestern Medicine Kishwaukee Hospital and Northwestern Medicine Valley West Hospital. By now you've met with an orthopaedic surgeon\* and set a date for your joint replacement surgery.

From this point on, the orthopaedic care team will be with you every step of the way. We look forward to giving you excellent care and service.

Two important things to do before your surgery are to read this book and attend a Joint Adventures class. The information in this book, plus much more, will be covered in detail during the class. Knowing what to do before your surgery and what to expect afterwards can help reduce the stress or fear you might have.

Besides reading this book and attending a class, you may also be advised to watch a web-based Emmi® education program about your joint surgery. Your surgeon's\* office can provide you with the web address and access code you'll need to view the video. Please contact your surgeon's\* office for this information.

Most of the questions you might have today should be answered after reading this book, watching the Emmi video and attending a Joint Adventures class. If you still have questions about your surgery schedule, physician appointments or medication, please call your physician's/surgeon's\* office. For other questions, please contact me directly using my cell phone number listed below.

Again, welcome to Kishwaukee Hospital and Valley West Hospital. The orthopaedic care team looks forward to helping make your joint adventure a pleasant one.

TTY for the hearing impaired: Kishwaukee Hospital, 815.766.9736; Valley West Hospital, 815.981.7313

\*In the spirit of keeping you well-informed, some of the physician(s) and/or individual(s) identified are neither agents nor employees of Northwestern Memorial HealthCare or any of its affiliates. They have selected our facilities as places where they want to treat and care for their private patients.



# Table of contents

## Getting Started

About your knee . . . . .	6
Arthritis . . . . .	7
Knee replacement . . . . .	7

## Preparing for Surgery

Physician visits and lab tests . . . . .	10
Dental care . . . . .	10
Infection prevention . . . . .	10
Health history . . . . .	11
Pre-op Nursing at Kishwaukee Hospital and Valley West Hospital . . . . .	11
Surgery time . . . . .	12
What to bring for your hospital stay . . . . .	12
Are you covered? . . . . .	13
Care Coordination Form . . . . .	13
Home health care . . . . .	13
Post-surgery care . . . . .	13
Choosing a coach . . . . .	14

## Health and Nutrition

Calcium . . . . .	16
Vitamin D . . . . .	18

## Day of Surgery

Arrival and parking . . . . .	20
Check-in and registration . . . . .	20
Waiting room . . . . .	20
Recovery room . . . . .	20
Food and fluids . . . . .	21
Visitors . . . . .	21
Privacy . . . . .	21

## Your Hospital Stay

Post-surgery . . . . .	24
Inpatient physical therapy . . . . .	24
Bladder and bowel care . . . . .	25
Incision care . . . . .	25
Respiratory care . . . . .	25
Circulation . . . . .	25

## **Managing Your Pain**

Comfort-function goal . . . . . 28

## **Discharge Instructions**

Discharge instructions for knee replacement . . . . . 30

Incision care . . . . . 31

Infection prevention . . . . . 32

Dental care . . . . . 32

Urological care . . . . . 32

Colonoscopy . . . . . 32

Deep vein thrombosis . . . . . 33

Pulmonary embolism . . . . . 33

## **Leaving the Hospital**

Discharged . . . . . 34

## **Safety Precautions**

Transfers . . . . . 36

Stairs . . . . . 39

Home precautions . . . . . 40

Adaptive equipment . . . . . 41

## **Outpatient Physical Therapy**

Outpatient rehabilitation services . . . . . 44

Pain management during physical therapy . . . . . 45

Exercises . . . . . 46

# Getting Started

# Getting started

To help you better understand the process of knee replacement, it may be helpful to know more about your knee and how it works.

The knee is the largest joint in the body.

The ability to walk easily depends on the specific way the thigh bone (femur) meets the shin bone (tibia).

These bones are separated by cartilage, which acts as a cushion and allows movement. In front of these bones, the kneecap (patella) glides in a groove and provides a round, protective shield. Much of the knee's stability and its main movements of bending and straightening depend on surrounding muscles and ligaments.

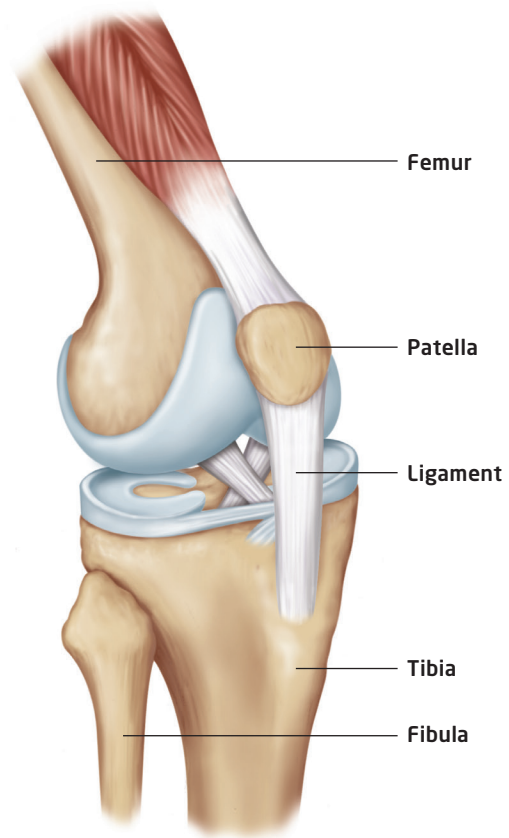



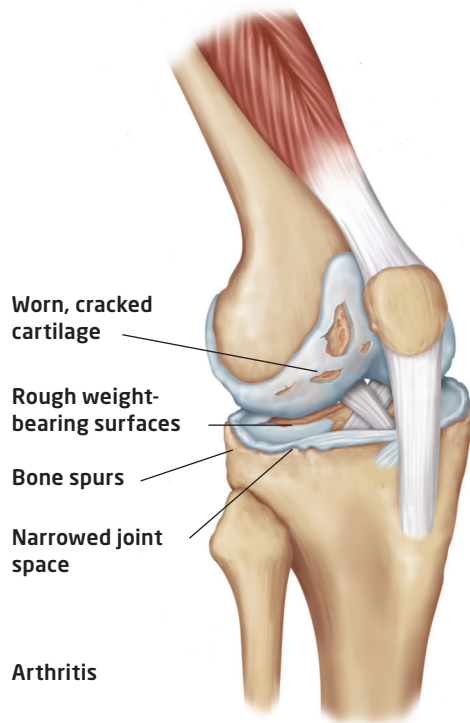

### Arthritis

The word “arthritis” means joint inflammation. Arthritis of the knee is a disease that wears away the cartilage of the knee joint. Without enough cartilage, the femur and the tibia rub on each other—bone on bone. When this happens, the joint becomes pitted and rough. The result is pain, stiffness and instability.

Osteoarthritis, often referred to as degenerative joint disease, usually gets worse with time. It is most common in people over age 50, but can occur at any age. Large, weight-bearing joints, such as the hip and knee, are the most common joints affected by osteoarthritis. People with osteoarthritis often get bone spurs around the joint. This can make it hard to move.

Rheumatoid arthritis is a disease that attacks any part of the body—including joints. In rheumatoid arthritis, the joint fluid contains chemical substances that attack and damage the joint surface. Swelling, pain and stiffness are usually present even when the joint is not used.

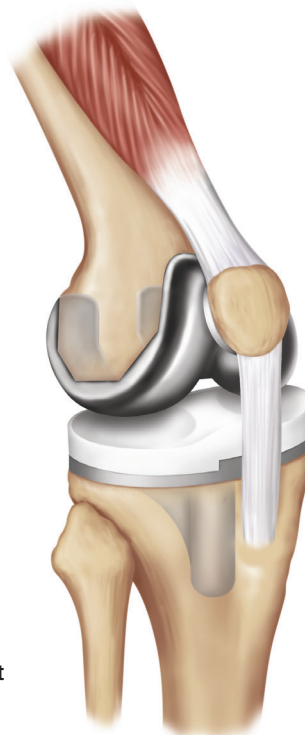

### Knee replacement

Knee replacement surgery removes damaged and worn parts of the knee and replaces them with artificial parts called prostheses. This makes the knee strong, stable and flexible again. The prostheses include the same basic parts as your own knee. The femoral component is inserted into the thigh bone. The tibial component is inserted into the top of the shin bone. The patellar component replaces the kneecap.

The new joint may be secured in two ways. The cemented method secures the knee joint in place using acrylic bone cement that sets within 15 minutes. The uncemented, or ingrowth, method allows the new joint to be secured into place by the body’s own bone growth. The decision about which method you will have should be discussed with your surgeon.\*

\*In the spirit of keeping you well-informed, some of the physician(s) and/or individual(s) identified are neither agents nor employees of Northwestern Memorial HealthCare or any of its affiliates. They have selected our facilities as places where they want to treat and care for their private patients.

Congratulations,  
You've taken the first  
step to regaining your  
active lifestyle.

However, you need to take a few more to ensure you, your home and your caregiver are fully prepared for your joint replacement surgery.

---

During the next few days and weeks, you will need to:

---

Register and attend a pre-operative knee replacement class at the hospital.

Watch educational internet programs as assigned by your physician\*.

Prepare your home for your return.

Complete and return the Care Coordination Form.

Complete lab work or other tests ordered by your physicians\*.

Select a support person to assist you at home for the first week after surgery.

---

### Pre-operative class

The pre-operative class and this book were created to help patients and family members better understand what to expect before and after joint replacement surgery.

### Steps to prepare for the pre-operative class

1. Bring this book with you to class and to the hospital the day of your surgery.
2. Select a family member or close friend who can be your "support person" (coach); your support person will need to attend the pre-operative class with you to learn and understand how to assist you.
3. Register for class 2 to 6 weeks prior to your surgery by calling Pre-op Nursing at 815.766.9093. TTY for the hearing impaired: Kishwaukee Hospital, 815.766.9736; Valley West Hospital, 815.981.7313.

Prior to your surgery, we recommend you watch any web-based programs that have been assigned to you.

\*In the spirit of keeping you well-informed, some of the physician(s) and/or individual(s) identified are neither agents nor employees of Northwestern Memorial HealthCare or any of its affiliates. They have selected our facilities as places where they want to treat and care for their private patients.



# Preparing for Surgery

# Preparing for surgery

Joint replacement is an elective surgery. Therefore, it is important that your state of health be evaluated thoroughly prior to undergoing the procedure.

## Physician visits and lab tests

Before surgery, most patients will complete an evaluation that may include a pre-operative physical exam, lab tests, EKG and X-rays. Please be sure to speak with a pre-admission review nurse before you go for testing; anesthesia guidelines may call for additional tests. Your physician\* also may discuss temporarily stopping the use of some medications, such as aspirin or other anti-inflammatory medications, about 1 week prior to surgery. These medications tend to make your blood thinner and could cause more bleeding during your surgery.

## Dental care before surgery

Any invasive dental work, including routine cleanings, cavity filling, extractions, root canals or implant work, can introduce bacteria into the bloodstream. If you are scheduled to have dental work within the 6 weeks prior to your joint replacement surgery, please tell your surgeon's\* office staff. Your surgeon\* may provide specific instructions or guidelines for you to follow. Consult your surgeon\* regarding the length of time to wait after surgery before scheduling any future dental appointments.

## Infection prevention

Infection is a rare complication of joint replacement surgery. **If you have any signs or symptoms of infection prior to surgery, such as an open sore, flu symptoms, a cut, infected teeth or a bladder infection, tell your physician\* immediately. Your surgery may need to be delayed until you receive appropriate treatment.**

While in the hospital, you will receive antibiotics before and after surgery to reduce your risk of infection.

If you have any signs or symptoms of infection prior to surgery, tell your physician\* immediately.

\*In the spirit of keeping you well-informed, some of the physician(s) and/or individual(s) identified are neither agents nor employees of Northwestern Memorial HealthCare or any of its affiliates. They have selected our facilities as places where they want to treat and care for their private patients.

Your incision needs to be kept clean and dry until it is healed. Your new joint is artificial and does not have your body's natural protection against infection, so it is possible to develop an infection years later. Bacteria can enter your bloodstream and invade your new joint causing it to become loose and painful. **Call your physician\* immediately if you experience signs or symptoms of infection such as fever, chills, pain, redness or drainage.**

Common infections include sore throat, urinary tract infection, deep cuts or an ear infection. Your physician\* may prescribe antibiotics.

### **Health history**

Once you have a confirmed surgery date, you will need to provide a complete health history. One of our experienced pre-admission nurses will call you to obtain your detailed health history.

After the phone interview, you will be given instructions for the next steps, such as what tests will be performed and where to go for testing. Based on your history, required testing will be scheduled at Kishwaukee Hospital or Valley West Hospital.

### **Pre-op Nursing at Kishwaukee Hospital and Valley West Hospital**

You will meet with a member of our pre-admission nursing team. One of our nurses will draw blood for labs and other testing, if required. The nurse will provide any pre-operative education. The Pre-op Nursing visit also provides you the opportunity to ask questions in person and become familiar with the hospital before surgery.

\*In the spirit of keeping you well-informed, some of the physician(s) and/or individual(s) identified are neither agents nor employees of Northwestern Memorial HealthCare or any of its affiliates. They have selected our facilities as places where they want to treat and care for their private patients.

### When is my surgery?

We will be able to confirm your surgical time after 2 pm the business day before your scheduled procedure. A member of the Surgical Services staff will call you and tell you when to arrive and also inform you of any day-of-surgery tests that have been ordered.

#### For patients at Kishwaukee Hospital

If you will not be home, or you miss our call, please contact us at 815.766.7440 after 5 pm, Monday through Friday, to confirm your surgery time. TTY for the hearing impaired 815.766.9736.

#### For patients at Valley West Hospital

If you will not be home, or you miss our call, please contact us at 815.981.7157 after 5 pm, Monday through Friday, to confirm your surgery time. TTY for the hearing impaired 815.981.7313.

---

#### During this call, you will be told:

---

Your scheduled surgery time

What time you need to arrive at the hospital

What time to stop eating and drinking the night before surgery

What medication(s) you are to take, if any, the morning of surgery, including insulin and any medications you should bring with you to the hospital

---

### What to bring to the hospital

Although you'll be in the hospital for a few days, you don't need to pack much. In fact, we recommend you pack as lightly as possible.

---

#### Here is a suggested list of what to bring to the hospital:

---

Insurance and Medicare cards

A list of all your known allergies (medication, food and environmental) and a description of your allergic reactions to each

Toiletries: toothbrush, toothpaste, comb, brush, deodorant, lotion, contact case or eyeglasses case, denture case, etc.

Your CPAP mask if you use one at night when you sleep

List of any special dietary requirements

Underwear, socks, loose comfortable pants or shorts, button-down shirts, and shoes to wear during therapy can be the same clothes you wear to the hospital the day of surgery.

This book and any materials provided to you by your surgeon\*

---

#### The "Do Not" list:

---

Do not wear makeup the day of surgery.

Do not bring cash or personal items such as jewelry or items of great value.

---

\*In the spirit of keeping you well-informed, some of the physician(s) and/or individual(s) identified are neither agents nor employees of Northwestern Memorial HealthCare or any of its affiliates. They have selected our facilities as places where they want to treat and care for their private patients.

### **Are you covered?**

Healthcare insurance is ever-changing. We suggest you call your insurance provider to discuss your coverage. It is much easier to plan for services and care when you know in advance what your insurance covers.

### **Care Coordination Form**

The Care Coordination Form in your pre-operative class folder is very important. This helps us know more about you and your post-surgery care preferences. Please take the time to fill it out and mail it at least two weeks prior to your surgery. If your surgery is scheduled within the next 2 weeks, please fax the completed form to 815.748.5784 or email it as an attachment to [jennifer.wood1@nm.org](mailto:jennifer.wood1@nm.org).

### **Northwestern Medicine Home Health & Hospice**

If you are discharged to your home, you may need visits from a home health nurse and physical therapist. Northwestern Medicine Home Health & Hospice offers a joint replacement program designed to provide you with excellent care after your joint procedure. These services are available immediately after surgery and continue until you make the transition to outpatient therapy. Northwestern Medicine Home Health cares for more than 150 joint replacement patients each month and is dedicated to maximizing your potential and providing the education required to minimize complications.

### **Northwestern Medicine Home Health post-surgery care**

Northwestern Medicine Home Health is just one of the choices you have for post-discharge care. If you do not have Medicare, we recommend you check with your insurance provider to see which agencies are in your network of providers.

If you would like to speak with a Northwestern Medicine Home Health representative prior to surgery to discuss post-discharge care, call 630.665.7000 or visit [homehealth.nm.org](http://homehealth.nm.org).

A Northwestern Medicine care coordinator (discharge coordinator) will help make the final arrangements with the home healthcare provider of your choice.

---

Before you leave the hospital, a Northwestern Medicine Home Health liaison can:

---

Meet with you and answer any questions you may have regarding home care.

Review all pertinent information regarding your medical history, surgical procedure and post-operative care, and report it to your home health team.

Identify and order needed equipment.

---

---

After you go home, Northwestern Medicine Home Health can provide the following services:

---

A registered nurse will assess your overall health, review medications and comfort level, and evaluate the surgical incision.

The nurse and therapist will tailor a home program to meet your specific needs. It will include physical therapy and occupational therapy if needed.

We will conduct a home safety evaluation and offer recommendations for making your environment safer during recovery.

Lab work will be performed as ordered to monitor blood-thinning medications. Results will be reported to your physician.\*

When it is time for you to start outpatient therapy, we can provide assistance in determining your needs and preferences.

We will communicate regularly with your physician.\*

---



### Choosing a coach

As you prepare for surgery, another important thing to decide is who will be your coach or support person once you're home. This can be a family member or friend. Whomever you choose should plan to attend the Joint Adventures pre-operative class with you, watch any assigned web-based programs and help prepare your home. Most important, your coach needs to be with you at least the first week after you return home. You may need assistance with meal preparation and daily activities. Your coach also will encourage and remind you to do your home physical therapy exercises.

\*In the spirit of keeping you well-informed, some of the physician(s) and/or individual(s) identified are neither agents nor employees of Northwestern Memorial HealthCare or any of its affiliates. They have selected our facilities as places where they want to treat and care for their private patients.





# Health and Nutrition

## Calcium

Most of the calcium in your body is stored in your bones and teeth. The rest is used in your blood, muscle and fluid between cells.

---

### Benefits of calcium

---

Regulates muscle contraction, including heartbeat  
May help control blood pressure

---

### Recommended daily allowance

---

Women age 19-50	1,000 mg
Women age 51-70	1,200 mg
Anyone over age 70	1,200 mg

---

### Tolerable upper limits

---

Age 19-50	2,500 mg
Age 51 and over	2,000 mg

---

## Calcium supplements

You may need a calcium supplement if you don't get enough calcium from the food you eat. Calcium carbonate is the least expensive supplement and it contains the highest amount of calcium per tablet. Calcium carbonate is available under the brand names OS Cal® and Caltrate® or generic calcium carbonate. Calcium also can be found in Tums®, an over-the-counter antacid.

The ingredient label on the back of the product lists the calcium content. Your body only can accept 500 mg of calcium at a time, so do not take more than that in one serving.

## Osteoporosis

Osteoporosis is a disorder where bone becomes weak and brittle. People with osteoporosis have an increased risk for broken bones. Osteoporosis may develop if your body doesn't get enough calcium.

---

### Osteoporosis risk factors

---

Post-menopausal women  
Small-boned women  
Fair-skinned women of Northern European origin  
Physically inactive individuals  
Family history of osteoporosis  
Alcohol and caffeine drinkers  
Tobacco users

---

### Factors that increase calcium absorption

---

Lactose	Calcium deficiency
Vitamin D	Pregnancy and lactation

---

---

### Factors that decrease calcium absorption

---

Fiber	Vitamin D deficiency
Oxalate	Menopause
Alcohol	Old age

---

<b>FOODS RICH IN CALCIUM</b>	<b>CALCIUM (MILLIGRAMS)</b>	<b>PERCENT DAILY VALUE</b>
Yogurt, plain, low-fat, 8 ounces	415	42%
Yogurt, fruit, low-fat, 8 ounces	245-384	25-38%
Sardines, canned in oil, with bones, 3 ounces	324	32%
Cheddar cheese, 1½ ounces, shredded	306	31%
Milk, non-fat, 8 fluid ounces	302	30%
Milk, reduced-fat (2% milk fat), no solids, 8 fluid ounces	297	30%
Milk, whole (3.25% milk fat), 8 fluid ounces	291	29%
Milk, buttermilk, 8 fluid ounces	285	29%
Milk, lactose-reduced, 8 fluid ounces	285-302	29-30%
Mozzarella, part skim, 1½ ounces	275	28%
Tofu, firm, made with calcium sulfate, ½ cup	204	20%
Orange juice, calcium-fortified, 6 fluid ounces	200-260	20-26%
Salmon, pink, canned, solids with bone, 3 ounces	181	18%
Pudding, chocolate, instant, made with 2% milk, ½ cup	153	15%
Cottage cheese, 1% milk fat, 1 cup unpacked	138	14%
Tofu, soft, made with calcium sulfate, ½ cup	138	14%
Spinach, cooked, ½ cup	120	12%
Instant breakfast drink, various flavors and brands, powder prepared with water, 8 fluid ounces	105-250	10-25%
Frozen yogurt, vanilla, soft serve, ½ cup	103	10%
Ready-to-eat cereal, calcium-fortified, 1 cup	100-1,000	1-100%
Turnip greens, boiled, ½ cup	99	10%
Kale, cooked, 1 cup	94	9%
Kale, raw, 1 cup	90	9%
Ice cream, vanilla, ½ cup	85	8.5%
Soy beverage, calcium-fortified, 8 fluid ounces	80-500	8-50%
Chinese cabbage, raw, 1 cup	74	7%
Tortilla, corn, ready to bake/fry, 1 medium	42	4%
Tortilla, flour, ready to bake/fry, one 6-inch diameter	37	4%
Sour cream, reduced-fat, cultured, 2 tablespoons	32	3%
Bread, white, 1 ounce	31	3%
Broccoli, raw, ½ cup	21	2%
Bread, whole wheat, 1 slice	20	2%

## Vitamin D

Vitamin D is a fat-soluble vitamin that is stored in the body's fatty tissue. It's also called the sunshine vitamin because the body makes vitamin D after being in sunlight.

### Vitamin D helps

- Promote calcium absorption
- Form and maintain strong bones
- Maintain the proper phosphorus levels in blood
- Prevent rickets

### Recommended daily allowance

- Age 19-70                      15 mcg or 600 IU
- Over age 70                    20 mcg or 800 IU
- Tolerable upper limit for any age is 4,000 IU

### Risk factors for vitamin D deficiency

- Age 50 and older
- Not enough exposure to sunlight
- Darker skin tones

### Vitamin D supplements

Vitamin D is needed to help your body absorb calcium. If you are not consuming the recommended daily allowance for vitamin D, you should talk with your physician\* about taking a daily supplement.

Vitamin D supplements are available over the counter from your local drug or vitamin store.

## FOODS RICH IN VITAMIN D

### INTERNATIONAL UNITS (IU) PER SERVING

### PERCENT DAILY VALUE

	INTERNATIONAL UNITS (IU) PER SERVING	PERCENT DAILY VALUE
Cod liver oil, 1 tablespoon	1,360	340
Salmon, cooked, 3½ ounces	360	90
Mackerel, cooked, 3½ ounces	345	90
Sardines, canned in oil, drained, 1¾ ounces	250	70
Tuna fish, canned in oil, 3 ounces	200	50
Milk, non-fat, reduced-fat, and whole, vitamin D fortified, 1 cup	98	25
Margarine, fortified, 1 tablespoon	60	15
Pudding, prepared from mix and made with vitamin D fortified milk, ½ cup	50	10
Ready-to-eat cereals fortified with 10% of the daily value of vitamin D, ¾ cup to 1 cup servings (servings vary according to the brand)	40	10
Egg, 1 whole (vitamin D is found in egg yolk)	20	6
Liver, beef, cooked, 3½ ounces	15	4
Swiss cheese, 1 ounce	12	4

# Day of Surgery

# Day of surgery

We have a few recommendations to help ensure the day of your surgery goes smoothly for you and your family.

## **When you arrive at Kishwaukee Hospital**

Use the main entrance on Route 23. Valet parking is complimentary and recommended the day of surgery. Wheelchairs are available if needed. Valet service is available starting at 5:30 am.

The surgical services check-in and registration area is on the second floor. You and your family/friends will wait there until you are taken to the pre-operative holding area. We ask that only one family member accompanies you to this area.

## **When you arrive at Valley West Hospital**

Use the main entrance on Main Street. Wheelchairs are available if needed.

The surgery registration desk is located near the front entrance. You and your family/friends will wait there until you are taken to the pre-operative holding area. We ask that only one family member accompanies you.

## **Waiting room**

During surgery, your family/friends may wait in the surgical lounge. The patient tracking board will provide up-to-date progress information to your family. Your surgeon\* will speak with your family when your surgery is over.

## **Recovery room**

The average length of stay in the recovery room is 2 hours. The medications used in anesthesia may cause blurry vision, a dry mouth, chills, nausea or a sore throat. You may have a drain near your surgical incision. When you are stable, you will be transferred to your room. Once awake, you will be encouraged to breathe deeply and cough. This will help clear out your lungs and prevent pneumonia.

\*In the spirit of keeping you well-informed, some of the physician(s) and/or individual(s) identified are neither agents nor employees of Northwestern Memorial HealthCare or any of its affiliates. They have selected our facilities as places where they want to treat and care for their private patients.

### **Food and fluids**

After surgery, you will be able to have ice chips if you are not sick to your stomach. You can progress to solid food when you and your surgeon\* feel you are ready. You will have intravenous (IV) fluids for 1 to 2 days after surgery. You will receive antibiotics, fluids and blood, if needed, through your IV.

### **Visitors**

On the day of surgery, we suggest that you keep visitors to a minimum and limit the amount of time they stay. You will feel very drowsy from the medications.

### **Privacy**

To protect your privacy after surgery, you will be requested to communicate directly with your family and friends regarding your condition. You will be asked to choose a password to protect your privacy if you are unable to update your family/friends yourself. Please advise family and friends they will need to provide the password to a nurse in order to obtain updates on your condition.



\*In the spirit of keeping you well-informed, some of the physician(s) and/or individual(s) identified are neither agents nor employees of Northwestern Memorial HealthCare or any of its affiliates. They have selected our facilities as places where they want to treat and care for their private patients.





# Your Hospital Stay

# Your hospital stay

## Post-surgery

Your orthopaedic care team will continue to closely monitor you after your surgery. They will check the color, movement and sensation in your legs. They will orient you to your new environment, where:

A nurse will create a personalized plan of care to meet your individual needs and work with other members of the orthopaedic care team.

A patient care technician will assist you with activities of daily living such as bathing, turning in bed and toileting

---

## Inpatient physical therapy

Physical therapy is one of the most important parts of your recovery. You will most likely begin physical therapy the day of your surgery. As an inpatient, you will receive physical therapy twice a day. Your surgeon\* and the rehabilitation services staff work together to develop an individualized therapy plan for you. You are encouraged to take pain medication on a regular basis while hospitalized. It is important to have adequate pain management to complete your rehabilitation.

During your therapy sessions, you will be instructed in exercises to help restore joint motion and strengthen the surrounding muscles. As you become stronger and progress toward your mobility goal, you will learn and practice how to:

- Properly move and turn in bed
- Get in and out of bed and chairs
- Walk and climb stairs – if appropriate to your home setting

Therapy after your discharge will be based on your health status, abilities and the mobility level you achieved in the hospital. Your focus should be to work toward your optimal functional level with your home health therapist.

\*In the spirit of keeping you well-informed, some of the physician(s) and/or individual(s) identified are neither agents nor employees of Northwestern Memorial HealthCare or any of its affiliates. They have selected our facilities as places where they want to treat and care for their private patients.

### **Bladder and bowel care**

Some people may find it difficult to urinate after surgery because of the anesthesia, pain medications and decreased mobility. If necessary, your surgeon\* may request a catheter be inserted to drain your urine.

Constipation can become another problem several days after surgery. Drink a lot of fluids and eat foods that are high in fiber. A stool softener and laxatives may be given to you.

### **Incision care**

Your incision will be covered by a dressing. Your wound must be kept clean, dry and covered. Wound care will be discussed before discharge.

### **Respiratory care**

Secretions tend to pool in the lungs and can lead to pneumonia. To prevent this, we will teach you to breathe deeply and cough, as well as how to use an incentive spirometer, which is a breathing device. This allows air to fill the tiny air sacs in the bases of your lungs. The deep breathing also helps to break up the mucus so you can "cough it out."

### **Circulation**

Lack of activity causes the blood to circulate more slowly and pool in the legs. This can lead to the formation of blood clots. To reduce this risk, your surgeon\* will order intermittent compression sleeves or foot cuffs for you to wear. Blood thinners also may be prescribed.

\*In the spirit of keeping you well-informed, some of the physician(s) and/or individual(s) identified are neither agents nor employees of Northwestern Memorial HealthCare or any of its affiliates. They have selected our facilities as places where they want to treat and care for their private patients.





# Managing Your Pain

# Managing your pain

You are at the center of your healthcare team. For the best possible outcome, we encourage you to be an active participant in your health care.

---

Participation takes many forms and includes:

---

- Providing information to your team
  - Educating yourself about your diagnosis and care plan
  - Knowing the medications you are taking
  - Expressing your questions and concerns
  - Telling your caregivers how you are feeling
- 

## Managing your pain

We are committed to helping you manage your pain throughout your stay. Pain is experienced by people of all ages and can occur anywhere in your body. Feelings can vary from dull aches to severe sensations.

You have the right to have your pain assessed and treated. To help us make you as comfortable as possible, we will regularly ask you to rate your level of pain using a numeric scale. The scale is from 0 to 10, with 0 being no pain and 10 being the worst pain possible. We are committed to helping you manage your pain throughout your stay.

## Comfort-function goal

In order to perform your daily activities, you will need to set a goal for managing your pain. This is called a comfort-function goal. Your comfort-function goal should be a pain rating that allows you to continue your important activities.

---

To help set your goal, consider:

---

The daily activities you need to do after surgery, such as coughing or breathing deeply, to prevent complications

The pain rating that will allow you to manage those activities comfortably

---

Your caregiver will help you with your comfort-function goal and answer questions about the pain rating scale.

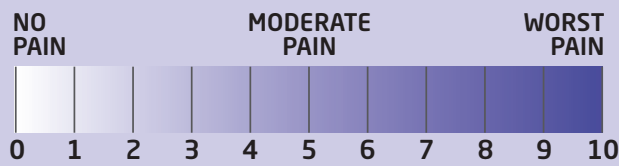



# Discharge Instructions and Leaving the Hospital

# Discharge instructions

Preparation for your discharge actually started the day your surgery was scheduled. Your orthopaedic care team works with your surgeon\* and medical physician\* to ensure a timely discharge. Part of the discharge process

includes a class you and your family and/or your coach are encouraged to attend. It is very important that everyone involved fully understands the discharge expectations.

---

## Discharge instructions for knee replacements

Before being discharged, the following information will be discussed with you and your family or coach.

---

### Assistive device

- Walker
  - Crutches
  - Cane
- 

### Weight bearing status for operated leg

- Weight bearing as tolerated
  - \_\_\_% of weight bearing
  - Touchdown weight bearing
  - No weight bearing
- 

### No pillows under operated knee

---

### Keep your appointments

---

### Review teaching tools

- Incision care at home
  - Prevention of infection
  - DVT sheet
- 

### Do not participate in running sports

---

### Resume driving when surgeon\* approves

---

### Return to work when surgeon\* approves

---

\*In the spirit of keeping you well-informed, some of the physician(s) and/or individual(s) identified are neither agents nor employees of Northwestern Memorial HealthCare or any of its affiliates. They have selected our facilities as places where they want to treat and care for their private patients.



## Incision care at home following joint replacement

---

Your incision will be closed on the outside by one of the following:

---

Staples

Dermabond

Steri-Strips®

---

When you are discharged from the hospital, these will still be in place. You will need to keep the incision clean and dry. If Steri-Strips are present, keep them in place until seen by your physician.\* If the ends come loose and curl up, they may be trimmed off. Leave the remaining Steri-Strip in place.

Each day, change the dressing that covers your incision until your first post-op visit with your surgeon.\* Follow the dressing change instructions provided.

---

Here are a few suggestions to help promote healing and avoid infection:

---

Keep your incision clean and dry. You may not shower until directed by your surgeon.\*

You may wash the area gently with soap and water, and pat dry after your first office visit. If you have staples, you may be asked to wait another couple of days after they are removed before showering.

Do not apply lotion or ointments to your incision unless directed by your surgeon.\*

---

---

Notify your surgeon\* if you notice any of the following:

---

Separation of incision line at any point

Increased temperature greater than 101 degrees, or chills

Increased redness, swelling or warmth of the skin around the incision

Increased pain at the incision site

Red streaks on the skin near the incision site

Tender bumps or nodules in your armpits or groin

Foul smell from the incision

Pus leaking from the incision

---

Please call your physician\* with any questions or concerns.

\*In the spirit of keeping you well-informed, some of the physician(s) and/or individual(s) identified are neither agents nor employees of Northwestern Memorial HealthCare or any of its affiliates. They have selected our facilities as places where they want to treat and care for their private patients.

### **Infection prevention**

Infection is a possible complication of joint replacement surgery. Therefore, it is very important to take good care of yourself with preventive care, screenings, tests and procedures. If you ever experience signs or symptoms of an infection such as fever, chills, pain, redness and/or drainage from the incision area, call your surgeon.\* An infection could start from a sore throat, urinary tract infection, deep cut or even an ear infection.

Some tests, diagnostic procedures and illnesses can place you at a greater risk for developing an infection in your new joint even years after surgery. That's because bacteria can be introduced into your bloodstream in any number of ways. Once in the bloodstream, the bacteria can travel to your new joint and cause an infection because the artificial joint does not have your body's natural protection against infection.

Three of the most common healthcare situations you might encounter that can cause an infection are dental care, urological care and colonoscopy.

### **Dental care**

Dental care after surgery can introduce bacteria into your bloodstream through cuts and trauma to the gums and gum lines. In anticipation of this risk, most surgeons\* recommend taking a one-time dose of antibiotics just prior to any dental work.

Your surgeon\* will have specific instructions and the length of time they need to be followed after joint surgery. Also, make sure your dentist and dental hygienist are aware of your new joint.

### **Urological care**

Invasive procedures involving the urethra, bladder, ureters or kidneys are ways that bacteria can enter your system and contaminate your bloodstream. Needle biopsies of the prostate are included in this risk. Under normal circumstances, the body can usually fight off potential infection associated with these procedures. However, that's not necessarily true after joint replacement surgery.

Make sure to inform any medical personnel about your artificial joint before they perform an invasive urological procedure. More important, talk to your orthopaedic surgeon\* before undergoing any urological procedure. Your surgeon\* will provide specific recommendations for you to follow. You also will be instructed how long to follow the recommendations after the procedure.

### **Colonoscopy**

Routine colonoscopy screenings are an important part of preventive care. However, a colonoscopy can introduce bacteria into the bloodstream and eventually your artificial joint. Speak with your surgeon\* and gastroenterologist\* about the precautions that need to be taken. Make sure you follow your physicians'\* recommendations to protect yourself and your new joint.

\*In the spirit of keeping you well-informed, some of the physician(s) and/or individual(s) identified are neither agents nor employees of Northwestern Memorial HealthCare or any of its affiliates. They have selected our facilities as places where they want to treat and care for their private patients.

### Deep vein thrombosis

Deep vein thrombosis (DVT) is the formation of a blood clot within a deep vein, commonly the calf or thigh. The blood clot can either partially or completely block the blood flow in the vein.

---

#### DVT can result from leg inactivity brought on by:

---

Surgery, especially on legs, hips, knees or abdominal area

Badly broken leg bones or other trauma

Immobility or being bedridden

Cancer

Myocardial infarction (heart attack) or congestive heart failure

Severe infection

Pregnancy

Use of oral contraceptives

Decreased circulation

Prior DVTs

---

Ankle pumps (see exercise on page 47) are important for increasing your blood circulation. These involve moving your ankles up and down and tightening your leg muscles. Your physical therapist will show you how to perform these exercises.

### DVT signs and symptoms

Because DVT can produce life-threatening complications, it is important for you to know and be able to recognize DVT symptoms. If you notice any of these symptoms, you should call your primary care physician\* immediately.

---

#### Any or all of the following can be symptoms of DVT:

---

Swelling in the calf or thigh area

Pain in the calf area or behind the knee

Increased pain with standing or walking

Warmth/redness/tenderness in the affected area

Low-grade fever

---

DVT also can occur without any of the above symptoms.

### Pulmonary embolism

The most common and serious complication of DVT is a pulmonary embolism (PE). A PE occurs when a blood clot breaks free from a vein wall and travels to the lung where it blocks an artery. A PE is life-threatening and needs immediate medical attention.

---

#### Signs and symptoms of a PE include:

---

Sudden onset of chest pain

Sudden unexplained cough or coughing up blood

Shortness of breath

Lightheadedness, dizziness or cold sweats

Feelings of restlessness, anxiety or rapid heartbeat

Sense of impending doom

---

\*In the spirit of keeping you well-informed, some of the physician(s) and/or individual(s) identified are neither agents nor employees of Northwestern Memorial HealthCare or any of its affiliates. They have selected our facilities as places where they want to treat and care for their private patients.

# Leaving the hospital

## **Discharged**

Once your physicians\* and orthopaedic care team determine you are ready to be discharged from the hospital, you will embark on your next level of rehabilitation. You and your physician will discuss your discharge plan. Your post-discharge plan will be designed to meet your needs.

We strongly recommend you have someone stay with you for at least 1 week after your discharge to help ensure a safer recovery.



\*In the spirit of keeping you well-informed, some of the physician(s) and/or individual(s) identified are neither agents nor employees of Northwestern Memorial HealthCare or any of its affiliates. They have selected our facilities as places where they want to treat and care for their private patients.



# Safety Precautions

# Safety precautions

Your orthopaedic care team will teach you safety precautions. Your incision site and body need time to heal and adjust to the new joint. Your surgeon\* will instruct you on when you can resume normal activities.

Before leaving the hospital, you will practice walking, transferring from your bed and a chair, and dressing yourself. If your home has stairs, you also will practice climbing stairs.

These basic tasks require you to use safety precautions to prevent injury to yourself and your new joint.

---

## Transfers in and out of bed (Illustration A):

---

Back up to the bed until you feel the back of your knees touching it.

Place your operated leg out in front of you.

Reach for the bed with one arm and keep the other arm on the walker.

Slowly lower yourself onto the bed.

Scoot back onto the bed as much as possible.

Lift one leg at a time onto the bed until both legs are supported.

Continue to move legs to the center of the bed.

Recline back.

To get out of bed, reverse the steps.

---

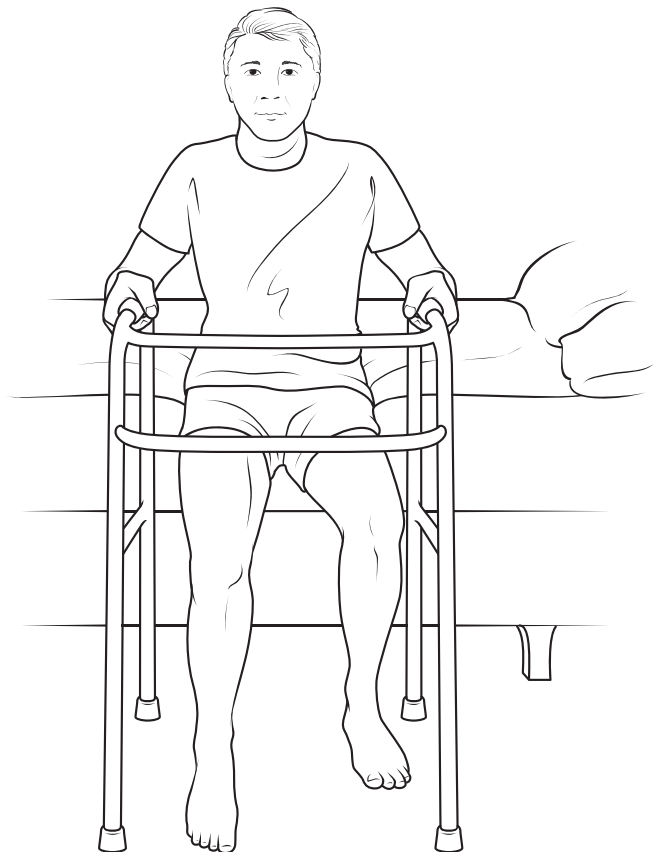

A

\*In the spirit of keeping you well-informed, some of the physician(s) and/or individual(s) identified are neither agents nor employees of Northwestern Memorial HealthCare or any of its affiliates. They have selected our facilities as places where they want to treat and care for their private patients.

## Transfers into and out of a chair

---

### Into a chair:

---

Back up to the chair until you feel the back of your knees touching it.

Place your operated leg out in front of you. If using crutches, move both crutches to one arm.

Reach for the armrests and slowly lower yourself onto the chair. Continue to keep the operated leg straight.

Scoot to the back of the chair.

---

---

### Out of a chair:

---

Scoot forward to the edge of the chair so both feet are on the floor.

Place your operated leg out in front of you and keep it there.

Bend your knee and hip on the non-operated leg and try to keep most of your weight on this leg.

Using your hands on the armrests, push yourself with your arms and non-operated leg to stand.

Do not use a walker to pull yourself up; that may cause the walker to tip and could result in a fall.

If using crutches, move crutches to one arm and push to stand with one arm on crutches and one arm on armrest.

---

\*In the spirit of keeping you well-informed, some of the physician(s) and/or individual(s) identified are neither agents nor employees of Northwestern Memorial HealthCare or any of its affiliates. They have selected our facilities as places where they want to treat and care for their private patients.

## Transfers in and out of a car

---

### Car transfers (Illustrations B and C):

---

Have the driver open the passenger-side front door for you and make sure the front seat is as far back as possible. You also can have the backrest reclined to maximize your space.

Back up to the car using your walker until the backs of your knees touch the edge of the car.

Place your operated leg out in front of you and keep it straight throughout the transfer.

Place one hand on the walker and the other hand on the frame of the vehicle.

Slowly lower yourself onto the edge of the seat.

Scoot as far back as possible on the seat.

Turn towards the dashboard (making sure not to bend torso/head forward) as you bring one leg into the car at a time.

Reposition the seat to allow for proper seatbelt function and comfort.

Have the driver close the door for you.

To get out of the car, reverse the steps.

---

### Recommendations:

---

Use a plastic trash bag on car seats for easier scooting and sliding.

Do not drive until your surgeon\* gives you permission.

---

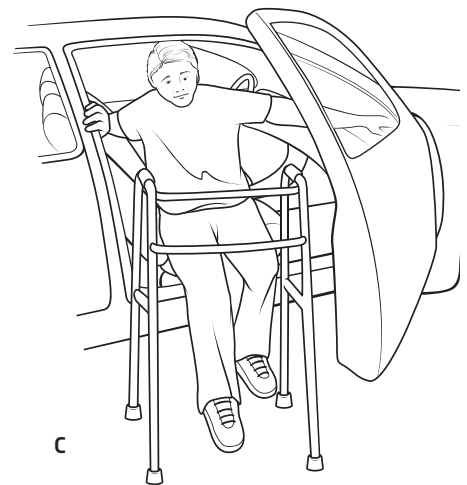
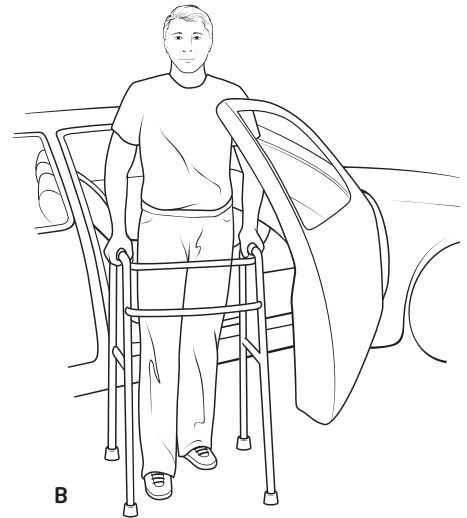

\*In the spirit of keeping you well-informed, some of the physician(s) and/or individual(s) identified are neither agents nor employees of Northwestern Memorial HealthCare or any of its affiliates. They have selected our facilities as places where they want to treat and care for their private patients.



## Stairs

---

### Going up stairs (Illustration D):

---

Use crutches or cane in one hand. With the other hand, hold onto the railing. Support your weight evenly, and lift non-operated leg onto the step.

Bring your operated leg up onto step, and then bring up cane or crutches.

If no railing, use crutches in both arms.

---

### Going down stairs (Illustration E):

---

Use crutches or cane in one hand. With the other hand, hold onto the railing.

Lower crutches or cane onto step below.

Support your weight evenly, and bring down operated leg.

Lower non-operated leg.

If no railing, use crutches in both arms.

---

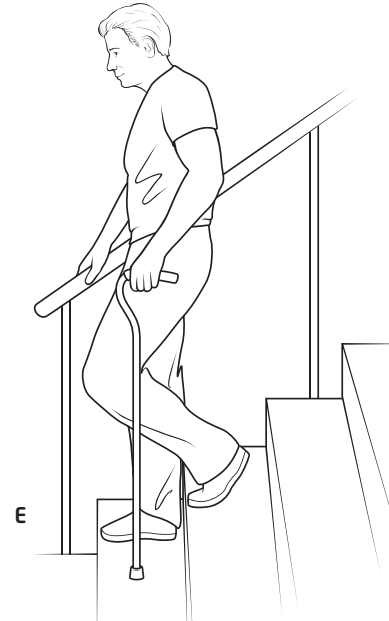

### Home precautions

To reduce the risk of falls or injury following surgery, it is important for you to make your home as safe as possible. This is fairly simple to do before your surgery. Most of the suggested modifications require no extra equipment or expense.

---

The following are home precautions you should follow:

---

Check hallways, stairs or traffic areas of your home for potential tripping hazards such as loose-carpeting throw rugs are addressed below.

Remove any clutter on the stairs.

Check the location of extension cords or phone cords to make sure they are not in a pathway.

Remove furniture that may cause a fall such as a rocking chair, glider, coffee table or ottoman.

The bathroom is the most accident-prone room in your home. Use non-slip strips on the bottom of the tub or shower.

Remove all throw rugs around the house and in the bathroom.

Install grab bars by the toilet, and in the shower or tub area. Soap dishes, towel bars or doorknobs are not acceptable substitutes for grab bars.

Place frequently used kitchen items in easily accessible places, such as on the countertop or tables. Items should be at or just below waist level, or just at shoulder height.

Do not use a "reacher" for overhead items.

If possible, have your bed accessible from both sides.

Do not use furniture that has casters.

Place portable phones in rooms where you will spend most of your time and in your bedroom.

Use nightlights in heavily traveled hallways and in bathrooms.

---

Your home care therapist will make recommendations for any other items you might need in the bathroom during the first visit following your discharge.

## Adaptive equipment

**3-in-1 commode**

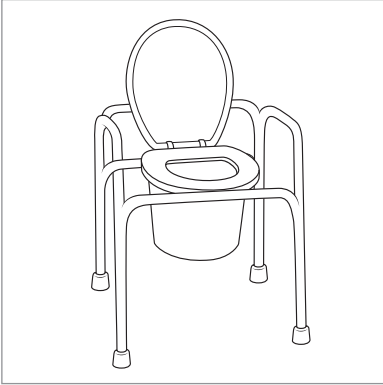

**Raised toilet seat**



**Raised toilet seat with arm and clamp**



**Toilet safety frame**



**Shower chair**

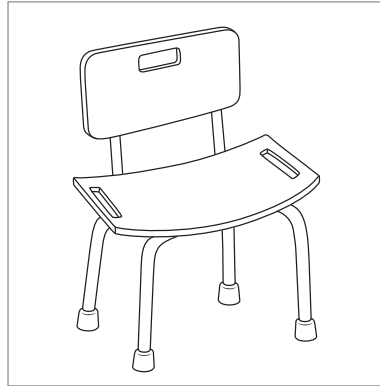

**Bathing sponge**

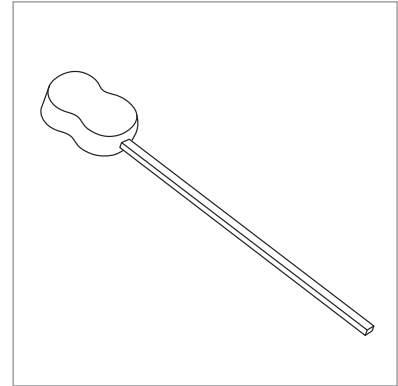

**Elastic laces**



**Spiro elastic laces**

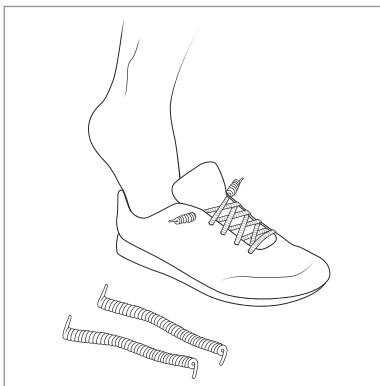

**Notes:**

---

---

---

---

---

---

---

---

---

---

---

---

---

---

---

---

---

---

---

---

---

---

---

---

---



# Outpatient Physical Therapy

# Outpatient physical therapy

Physical therapy is the most important part of your joint recovery. Your surgeon\* can implant a new joint, but it is your job to do the required physical therapy exercises to ensure your joint returns to an optimum functioning level. We recommend you work with a physical therapist specially trained in orthopaedics and joint replacement.

The physical therapist will instruct you on the correct exercises, as well as how and when to increase your exercise time and repetitions.

---

**In the hospital immediately after your surgery, your physical therapist will:**

---

Work with you to get you up and walking – in most cases, the same day of your surgery

Work with you twice a day until you are discharged

Instruct you on the correct exercises

Explain how and when to increase your exercise time and repetitions

---

After discharge, your therapy can continue at your home with another member of the orthopaedic care team – a Northwestern Medicine Home Health physical therapist.

## **Northwestern Medicine outpatient physical therapy**

You will continue physical therapy at home until your therapist and surgeon\* decide you can progress to outpatient physical therapy. At this point, you have an important decision to make on where to continue your physical therapy. You can continue with yet another member of our orthopaedic care team—a Northwestern Medicine outpatient physical therapist.

Through Northwestern Medicine, you can choose from 45 outpatient physical therapy locations in Greater DeKalb County and the western suburbs. Our licensed physical therapists will work together and communicate with your physician\* during your rehabilitation process. They also will develop a program to meet your individual needs and goals.

Your one-on-one therapy sessions can be with the same therapist during your entire outpatient treatment. This helps to ensure continuity and the ability to measure and accurately report your progress to your physician.\* Plus your medical records are accessible 24/7 to both your physician\* and therapist.

\*In the spirit of keeping you well-informed, some of the physician(s) and/or individual(s) identified are neither agents nor employees of Northwestern Memorial HealthCare or any of its affiliates. They have selected our facilities as places where they want to treat and care for their private patients.

---

When deciding where you will go for outpatient therapy, consider the following:

---

Is the therapist licensed or a trainer/instructor?

Will you be working one-on-one with that therapist during your entire therapy session?

Will you have therapy with the same individual throughout your rehabilitation?

How will the therapist communicate your progress to your surgeon\*?

Will the therapist have access to your medical records?

---

Ask the following questions about the facility:

---

What type of accreditation does this outpatient facility have?

How long has it been treating patients?

What is the most common type of treatment performed at this facility?

How much experience does it have with joint replacements?

How many joint replacement patients has it treated?

Does it have evening and weekend appointment times?

Is this facility in your insurance network?

---

### **Pain management during physical therapy**

It is important to have adequate pain management to reach your optimal functioning level, but still be able to exercise. If you haven't had any pain medication within 3 hours of your scheduled physical therapy session, we suggest you take some at least 30 minutes before you begin exercising.

With time, you should be able to decrease the amount of pain medication required. If your pain level and need for pain medication don't decrease after several weeks, discuss the situation with your physical therapist.

# Exercises

Exercise is very important following your knee replacement surgery.

The exercises on the next few pages are recommended before and after surgery. Your physical therapist also may give you additional exercises not listed in this book. Do only those exercises approved by your physical therapist.

Begin with 10 repetitions of each exercise at least 2 times a day. As you get stronger, you can increase the number of repetitions and duration.

---

**Remember:**

---

Exercises should be done on a firm surface.

Don't hold your breath while doing these exercises.

Take your pain medication 30 minutes before your therapy session if you haven't had any in the past 3 hours. Pain management is important in order for you to maximize your therapy.

---



## ANKLE PUMPS

---

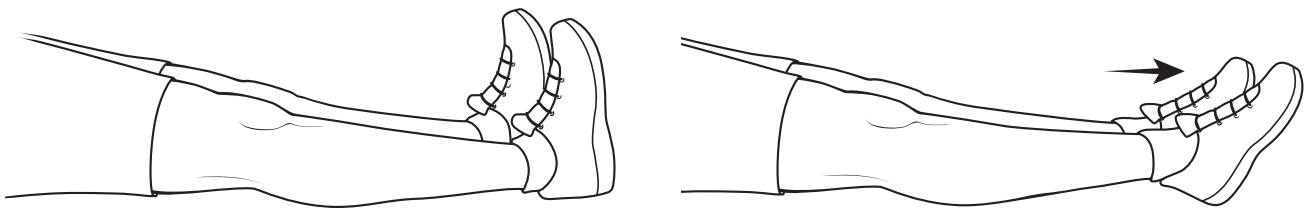

With your legs straight, gently flex and extend your ankles, moving through full range of motion. Repeat 10 times for each leg.

## QUAD SET

---



With your legs straight, tighten the top of your thigh to make the knee as straight as possible. Hold the contraction and count to 5. Relax, and don't forget to breathe. Repeat 10 times for each leg.

### HAMSTRING SET

---

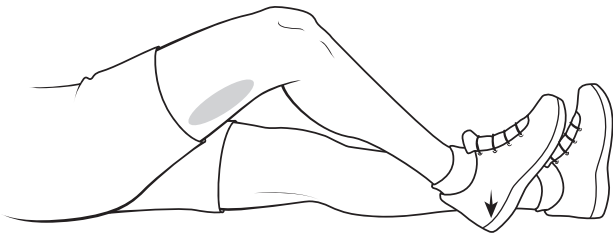

Lie on your back with your operated leg slightly bent; push your heel into the bed. Hold for a count of 5. Relax. Repeat 10 times.

### GLUTEAL SET

---

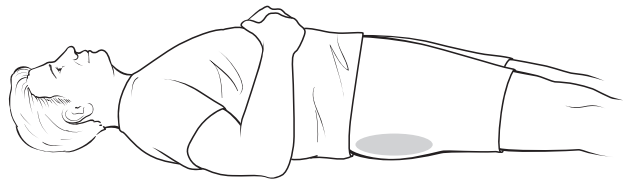

With your legs straight, squeeze your buttocks together and count to 5. Relax. Repeat 10 times.

### SHORT ARC QUAD

---

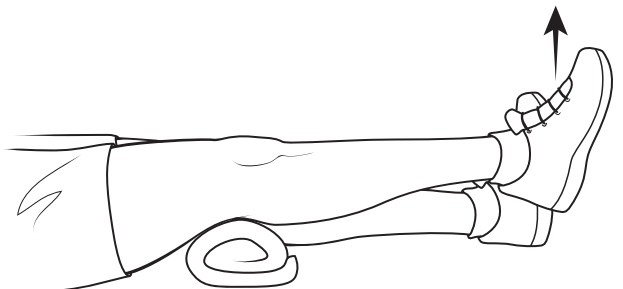
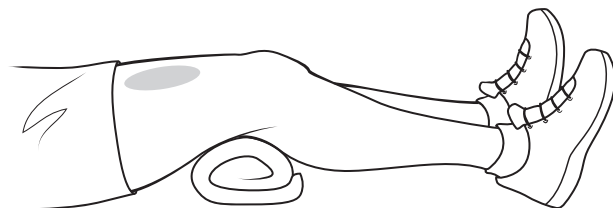

With a rolled up towel or pillow under your knee, tighten your thigh to lift your heel off the bed and straighten your knee. Hold for a count of 5. Don't forget to breathe. Slowly lower your leg. Repeat 10 times for each leg.

## HEEL SLIDES

---

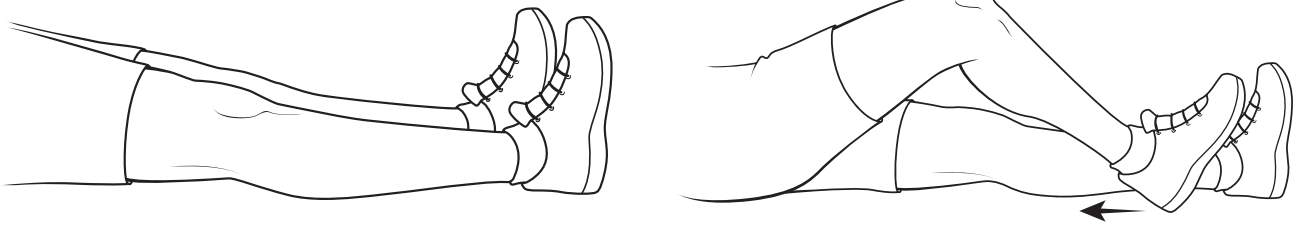

Lie on your back with your legs straight. Bend your knee by sliding your heel toward your buttocks as far as possible. Hold and count to 5. Slide your heel and leg back to a straight position. Relax. Repeat 10 times for each leg.

## STRAIGHT LEG RAISE

---



Lie on your back. Tighten muscles on front of your thigh, then slowly lift your leg 6 to 8 inches while keeping your knee straight. Then, slowly lower your leg. Repeat 10 times for each leg.

## PRONE KNEE FLEXION

---

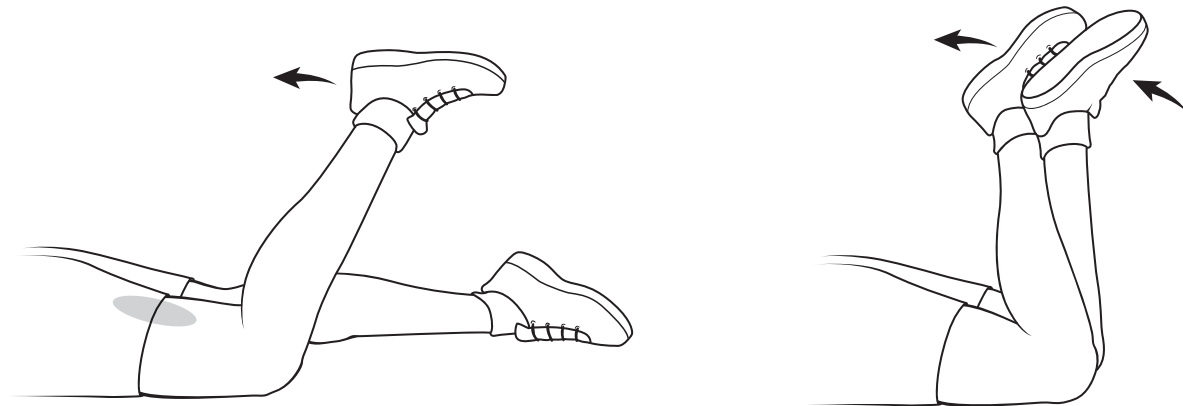

Lie on your stomach. Slowly bend your operated knee as far as you can toward your buttocks. Then with your other leg, gently press the operated leg to try and bend it more. Hold for 5 seconds. Repeat 10 times.

## SITTING HEEL SLIDE

---

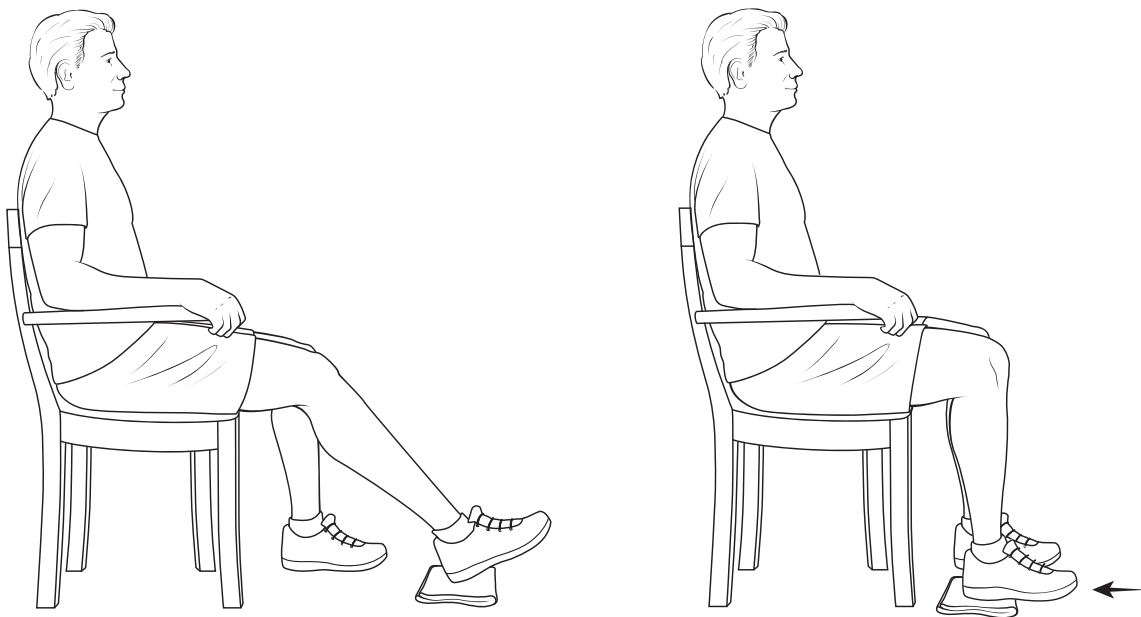

Sit in a chair with one leg extended and that foot resting on a piece of wax paper or aluminum foil on a carpeted surface, or a towel on a smooth surface. Press down on your extended heel and slide it toward the chair, keeping your heel flat and on the floor. With your heel still on the wax paper or foil, extend your leg pushing your foot away from the chair. Make sure to keep your heel on the floor. Repeat the forward and back movements 10 times for each leg.

## SITTING KNEE EXTENSION

---

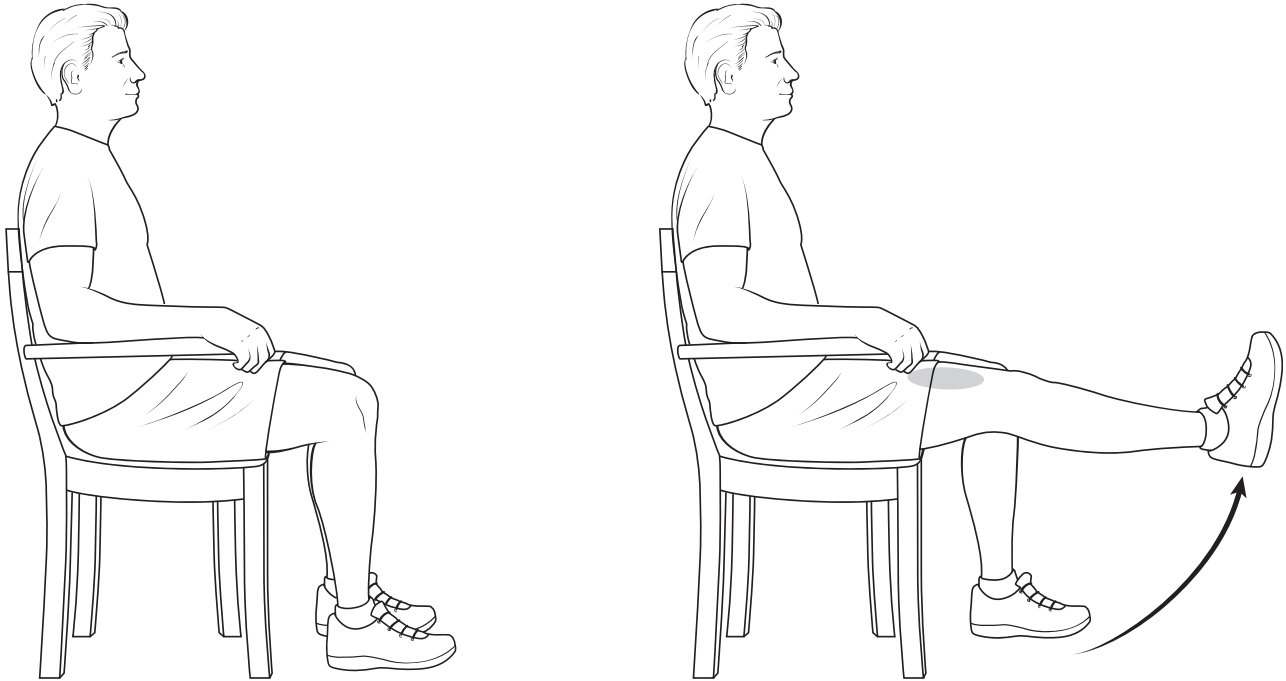

Sit in a chair with your feet on the floor. Slowly, extend one knee as straight as possible, tightening the top of your thigh. Hold for a count of 5 and then slowly lower your leg. Repeat 10 times for each leg.

## STANDING HEEL RAISES

---

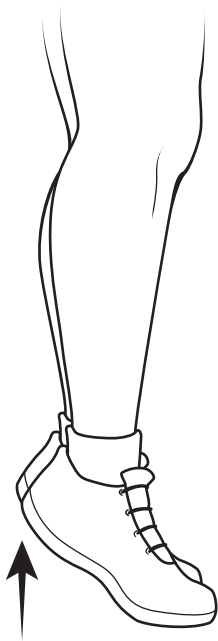

Hold the back of a chair or a counter for balance. Slowly, raise both heels off the floor so you are standing only on your toes. Repeat 10 times.

## STANDING HIP EXTENSION

---



Hold the back of a chair or a counter for balance. Slowly, extend one leg behind you, keeping your knee straight. Then, slowly lower the leg to a standing position. Repeat 10 times for each leg.

## STANDING HIP ABDUCTION

---

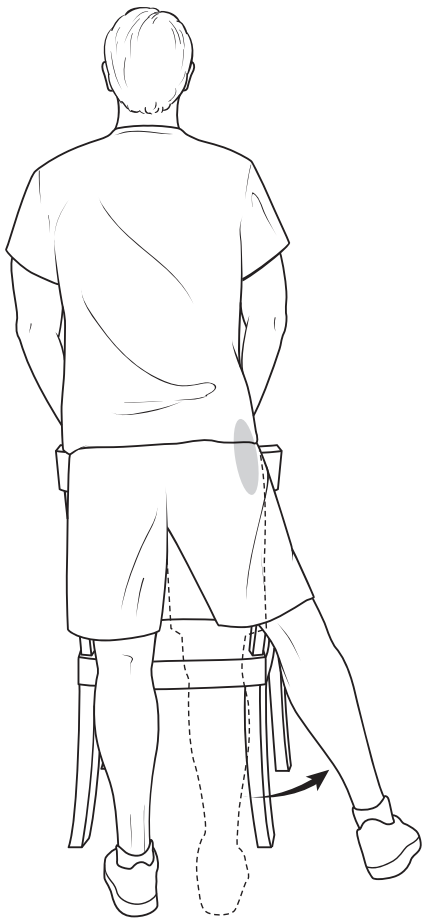

Holding the back of a chair or counter for balance, slowly raise one leg out to the side, keeping your leg straight. Then, slowly return the leg to a standing position. Repeat 10 times for each leg.

## MINI SQUAT

---

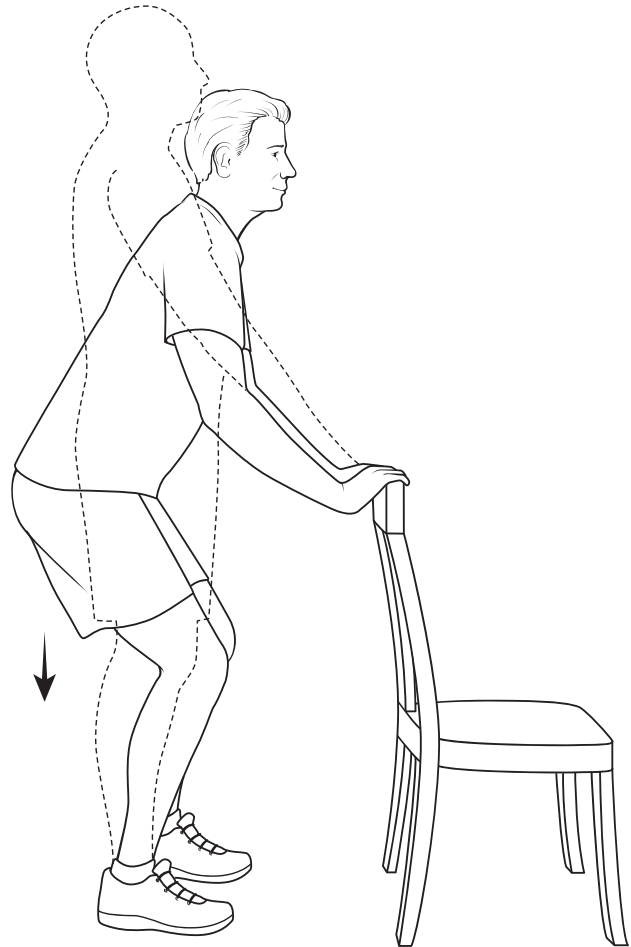

Holding the back of a chair or counter for balance, stand with your feet flat on the floor and shoulder-width apart. Slowly, bend both knees to a comfortable range, and then slowly straighten both legs to a standing position. Repeat 10 times.



**Northwestern Medicine Kishwaukee Hospital**

1 Kish Hospital Drive  
DeKalb, Illinois 60115  
815.766.9981

TTY for the hearing impaired 815.766.9736

**Northwestern Medicine Valley West Hospital**

1302 North Main Street  
Sandwich, Illinois 60548  
815.786.8484

TTY for the hearing impaired 815.786.3711

[nm.org/ortho](https://nm.org/ortho)